



SHINING 3D®

EinScan[®] HX

Hybrid Blue Laser & LED Light Source
Handheld 3D Scanner



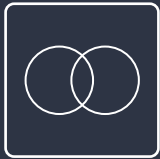

Hybrid Blue Laser & LED Light

Innovatively integrated with dual blue LED light and blue laser, improves scanning materials adaptability with less limitation for a wider range of applications.

LED light scanning allows rapid 3D scanning.

Laser scanning, which is less sensitive to ambient light, gives better performance to reflective and dark color surface.

Based on years of 3D measurement experience and market demand, SHINING 3D innovatively integrates blue LED light and blue laser into EinScan HX handheld 3D scanner. The hybrid laser and LED light sources make EinScan HX compatible with a wider range of object sizes, meeting multiple needs of users. High efficiency and reliable result give EinScan HX more application possibilities.

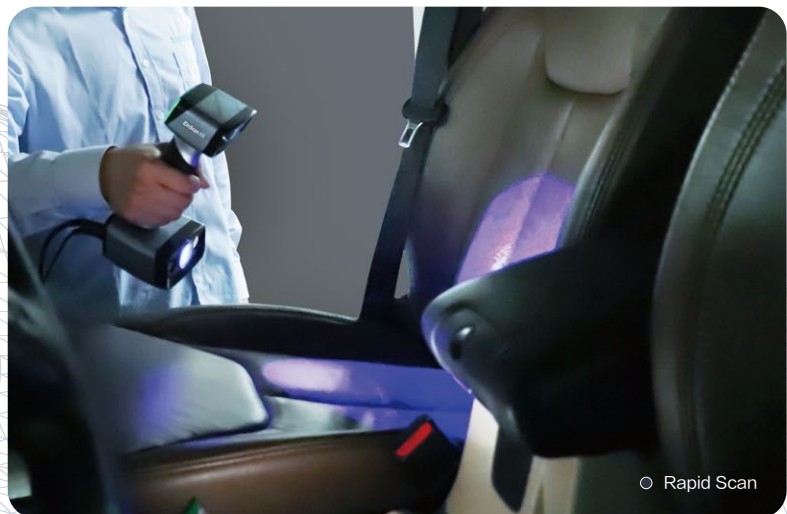



High Efficiency

Processing speed of EinScan HX under Rapid Scan Mode is up to 1,200,000 points/s, and multiple blue laser lines under Laser Scan Mode makes scanning of most objects in minutes for reverse engineering, CAD/CAM, 3D printing and etc.



0.04mm

Reliable Results

The high resolution and accuracy meet the needs of most industrial application for reverse engineering and measuring.

Minimum point distance of **0.05mm**;
accuracy up to **0.04mm** under laser mode



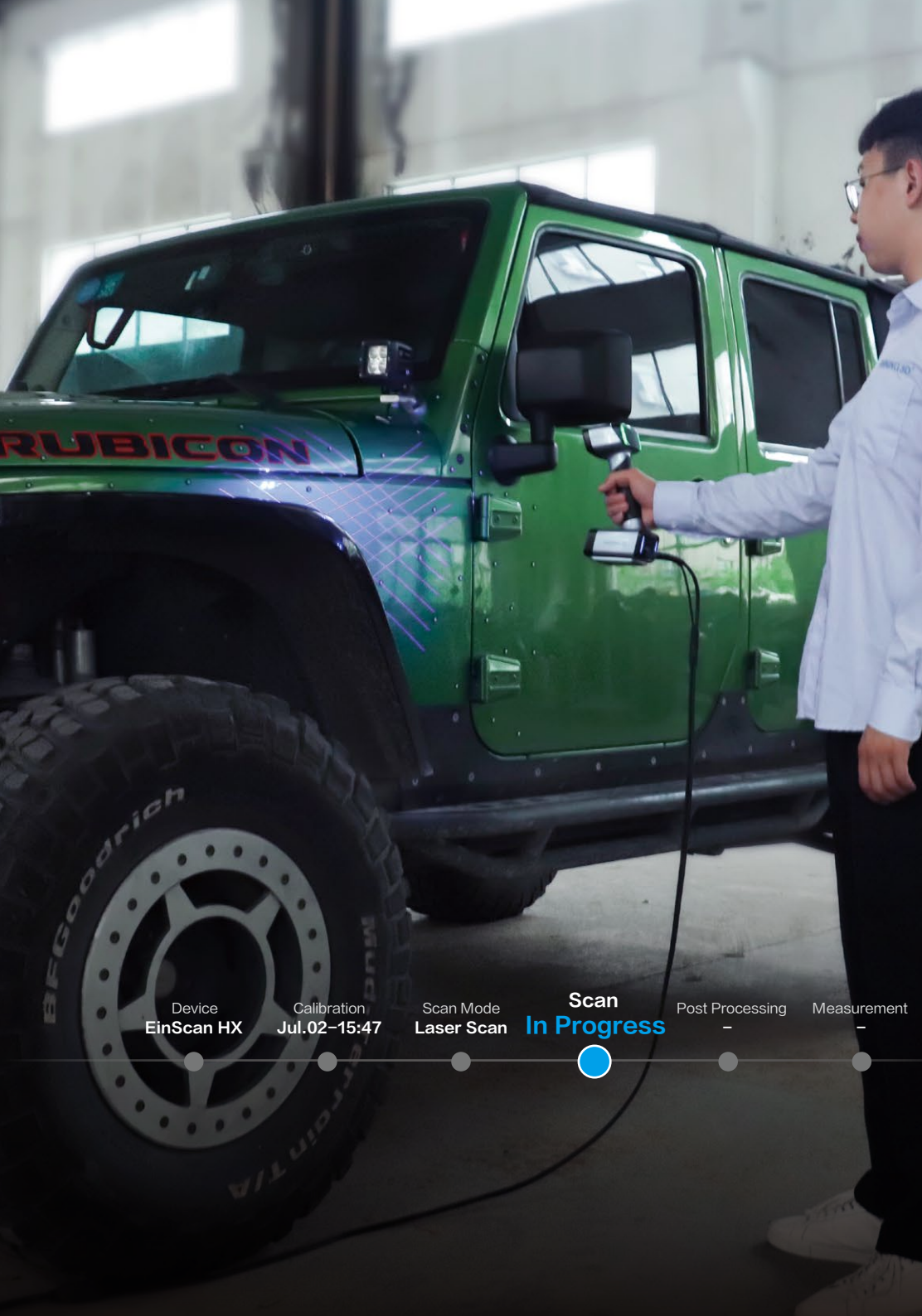

Portable & Easy Operation

EinScan HX is plug and play with user friendly software, which is easy to operate, no matter you are newbie or with professional experience in 3D scanning. The portability and flexibility use of EinScan HX has been considered to its ergonomic design for a more efficient and comfortable scanning experience.

Device
EinScan HX

Calibration
Jul.02-15:47

Scan Mode
Laser Scan

Scan
In Progress

Post Processing
-

Measurement
-

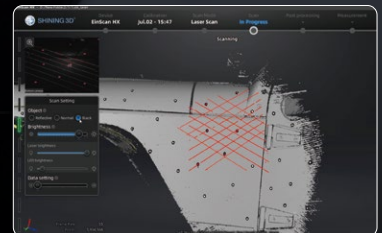



Full Color

With built-in color camera, it supports full color texture capturing and tracking by texture.

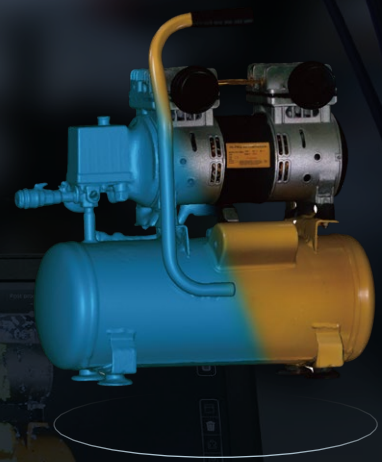

APPLICATIONS



Automotive



Shipbuilding



Machining

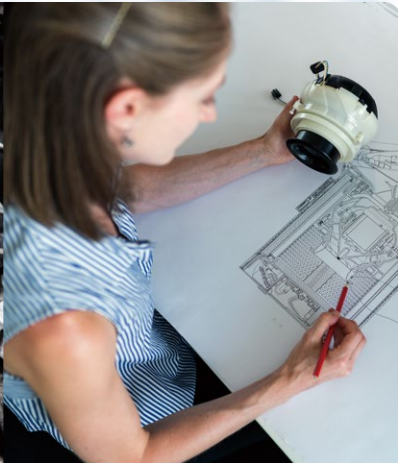

Education and Research

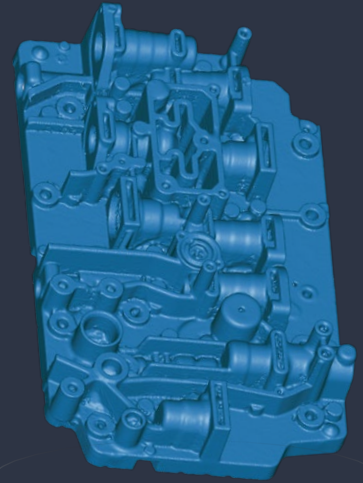
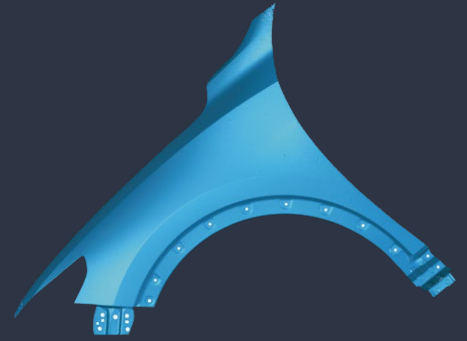

TECHNICAL SPECIFICATIONS

EinScan HX

Scan Mode	Rapid Scan	Laser Scan
Scan Accuracy	Up to 0.05mm	Up to 0.04mm
Volumetric Accuracy*	0.05+0.1mm/m	0.04+0.06mm/m
Scan Speed	1,200,000 points/s 20FPS	480,000 points/s 55FPS
Camera Frame Rate	55FPS	55FPS
Align Mode	Feature Alignment, Markers Alignment, Texture Alignment, Hybrid Alignment	Markers Alignment
Working Distance	470mm	470mm
Depth of Field	200mm–700mm	350mm–610mm
Max FOV	420mm*440mm	380mm*400mm
Point Distance	0.25mm – 3mm	0.05mm–3mm
Light Source	Blue LED	7 Blue Laser Crosses
Safety	Eye-safe	Class I (Eye-safe)
Built-in Color Camera	Yes	
Texture Scan	Yes	No
Connection Standard	USB3.0	
Output Formats	OBJ; STL; ASC; PLY; P3 ; 3MF	
Dimensions	108mmx110mmx237mm	
Weight	710g	
Operating Temperature Range	0–40°C	
Operating Humidity Range	10–90%	
Certifications	CE, FCC, ROHS, WEEE, KC	
Recommended Configuration	OS: Win10, 64 bit; Graphics card: NVIDIA GTX/RTX series cards, higher or equal to GTX 1080; Video memory: ≥4G; Processor: I7–8700; Memory: ≥32GB	

* Volumetric accuracy refers to the relationship between 3D data accuracy and object size; the accuracy is reduced by 0.1mm (rapid scan)/0.06mm(laser scan) per 100cm.The conclusion is obtained by measuring the center of sphere under marker alignment.